



RS225602

Material Details

- Body: Brass with nickel plated
- PIN: Brass with silver plated
- Insulator: PE

Technical

- Temp.range: $-40\sim+60^{\circ}\text{C}$
- Impedance: 75Ω
- Frequency Range: $\text{DC}\sim 3\text{GHz}$
- Working Voltage: 170V max
- Withstand Voltage: 500V rms
- Center contact $\leq 10\text{m}$
- Outer contact $\leq 5\text{m}\Omega$
- Insulation resistance: $5000\text{M}\Omega$
- VSWR: ≤ 1.3
- Durability: 500(cycles)

Package

100pcs in naylor bag

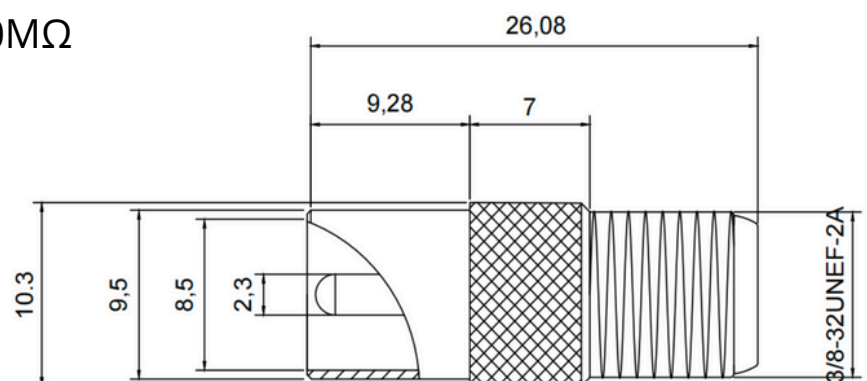

PRODUCT NUMBER:
JY4-020A

Liyao Road,Danyang city,jiangsu province,China